



CORECO



GAMA AMERICANA *US RANGE*

BAJO COCINA - *UNDER BROILER*

Pag. **240-241**

Mesa fría GN 2/1, refrigeración BAJO COCINA
GN 2/1 counter, chiller UNDER BROILER

MESA FRIA - *PREPARATION COUNTER*

Pag. **242-243**

Mesa fría refrigeración y congelados
Refrigerated counter, chiller and freezer

Pag. **244-245**

Mesa fría puerta de cristal
Glass door refrigerated counter

Pag. **246-251**

Mesa fría preparación
Preparation refrigerated counter

ARMARIOS - *CABINETS*

Pag. **252-255**

Armario GN 2/1, refrigeración y congelados
GN 2/1 cabinet, chiller and freezer



KBR-47



KBR-65



KBR-83

| mod. | rango range | largo length (mm) (inch) | alto height (mm) (inch) | fondo depth (mm) (inch) | estantes shelves GN 1/1 | pares guías slides sets | volumen capacity (L) | voltaje voltage | refrigerante refrigerant | potencia frig. frig. power W | potencia power W | CCE EEC 2015/1094 EN16825 | clase climate 2015/1094 EN16825 |
|--------|----------------|-----------------------------------|---|---------------------------------------|---------------------------------------|----------------------------|----------------------------|--------------------|-----------------------------|------------------------------------|------------------------|------------------------------------|--|
| KBR-47 | -2°C +8°C | 28°F 46°F | 1210 47 ² / ₃ | 600 23 ⁵ / ₈ | 700 27 ¹ / ₂ | 0 | 169 | 230V-50Hz | R134a* | 304 | 314 | D | 5 40°C 40% |
| | | | | | | | | | R290 | 502 | 250 | D | 5 40°C 40% |
| KBR-65 | -2°C +8°C | 28°F 46°F | 1660 65 ¹ / ₃ | 600 23 ⁵ / ₈ | 700 27 ¹ / ₂ | 0 | 264 | 230V-50Hz | R134a* | 304 | 314 | E | 5 40°C 40% |
| | | | | | | | | | R290 | 502 | 270 | D | 5 40°C 40% |
| KBR-83 | -2°C +8°C | 28°F 46°F | 2110 83 ¹ / ₁₆ | 600 23 ⁵ / ₈ | 700 27 ¹ / ₂ | 0 | 359 | 230V-50Hz | R134a* | 304 | 314 | E | 5 40°C 40% |
| | | | | | | | | | R290 | 502 | 276 | D | 5 40°C 40% |

* ver pag 13- see pag 13

Características técnicas y constructivas sujetas a variación sin previo aviso.

- Exterior en acero inox AISI-304, excepto el respaldo y fondo
- Interior en acero inox AISI-304, con aristas curvas y fondo embutido
- Cajoneras refrigeradas inox desmontables sobre guías inox telescópicas, sistema auto-cierre de serie
- Encimera de acero inox AISI-304 con frente curvo (opcional con peto sanitario 100 mm)
- Posibilidad de fabricar encimera especial a medida
- Pies en tubo de acero inox ajustables en altura 95- 135 mm
- Unidad condensadora ventilada y extraíble
- Evaporador sistema tiro forzado, con recubrimiento epoxi anticorrosión
- Evaporación automática del agua de descarche
- Aislamiento de poliuretano inyectado, densidad 40 Kg/m³, cero GWP y cero efecto ODP
- Control digital de temperatura, descarches optimizados, alarma por alta temperatura de condensación. Eficiente gestión del consumo de energía
- Temperatura de trabajo a 40°C ambiente

We reserve the right to change specifications without prior notice.

- AISI-304 stainless steel exterior, except rear side and base
- AISI-304 stainless steel interior, stamped bottom and rounded corners
- Stainless steel drawers with telescopic stainless steel slides for complete opening, self-closing system as standard
- AISI-304 stainless steel worktop, with rounded front (optional with 100 mm sanitary upstand)
- Worktop can be customized on demand
- AISI -304 adjustable legs, 95 to 135 mm
- Removable and fan assisted condenser unit
- Fan assisted evaporator, with epoxi anticorrosion coating.
- Automatic evaporation of defrost water
- 40 Kg/m³ density polyurethane insulation, zero GWP and zero ODP effect
- Digital temperature control, optimized defrost, high-temperature condensation alarm. Efficient management of energy consumption
- Operating temperature 40°C ambient

OPCIONES

motor lado izquierdo
encimera con peto
set 4 ruedas
set 6 ruedas
respaldo inox
230V 60Hz / 115V 60Hz

OPTIONS

left side motor
worktop with splash-back
set 4 wheels
set 6 wheels
SS rear side
230V 60Hz / 115V 60Hz

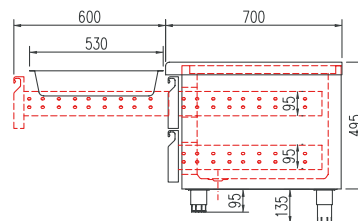



335
Kg/m²

70
Kg/ud



KBR-83

US RANGE 7





| |
|--------|
| SD-27 |
| SDN-27 |

| |
|--------|
| SD-48 |
| SDN-48 |

| |
|--------|
| SD-60 |
| SDN-60 |

| |
|-------|
| SD-72 |
|-------|

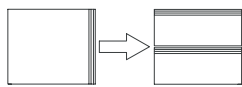

SD: Incremento precio por cambio de puerta a cajonera doble, sistema autocierre
SD: Door to double drawers set, soft-closing system, increase of price

Cajones sólo modelos -2°C +8°C
 Drawers only for -2°C +8°C

| mod. | rango range | largo length (mm) (inch) | alto height (mm) (inch) | fondo depth (mm) (inch) | estantes shelves uds | volumen capacity (L) | voltaje voltage | refrigerante refrigerant | potencia frig. frig. power W | potencia power W | CCE EEC 2015/1094 EN16825 | clase climate 2015/1094 EN16825 | |
|--------|----------------|---|---|--|---------------------------------------|----------------------------|--------------------|-----------------------------|------------------------------------|------------------------|------------------------------------|--|------------|
| SD-27 | -2°C +8°C | 701 27 ³ / ₅ | 915 36 ¹ / ₃₂ | 805 32 ¹ / ₉ | 2 | 204 | 230V-50Hz | R134a* | 304 | 343 | - | 5 40°C 40% | |
| | | | | | | | | R290 | 502 | 264 | C | 5 40°C 40% | |
| SD-48 | -2°C +8°C | 1228 48 ¹ / ₃ | 915 36 ¹ / ₃₂ | 805 32 ¹ / ₉ | 4 | 394 | 230V-50Hz | R134a* | 336 | 286 | - | 5 40°C 40% | |
| | | | | | | | | R290 | 502 | 725 | C | 5 40°C 40% | |
| SD-60 | -2°C +8°C | 1532 60 ⁵ / ₁₆ | 915 36 ¹ / ₃₂ | 805 32 ¹ / ₉ | 4 | 500 | 230V-50Hz | R134a* | 485 | 455 | - | 5 40°C 40% | |
| | | | | | | | | R290 | 845 | 929 | D | 5 40°C 40% | |
| SD-72 | -2°C +8°C | 1837 72 ¹ / ₃ | 915 36 ¹ / ₃₂ | 805 32 ¹ / ₉ | 6 | 606 | 230V-50Hz | R134a* | 540 | 470 | - | 5 40°C 40% | |
| | | | | | | | | R290 | 845 | 935 | D | 5 40°C 40% | |
| SDN-27 | -20°C -15°C | -4°F +5°F | 701 27 ³ / ₅ | 915 36 ¹ / ₃₂ | 805 32 ¹ / ₉ | 2 | 204 | 230V-50Hz | R290 | 361 | 300 | D | 4 30°C 55% |
| SDN-48 | -20°C -15°C | -4°F +5°F | 1228 48 ¹ / ₃ | 915 36 ¹ / ₃₂ | 805 32 ¹ / ₉ | 4 | 394 | 230V-50Hz | R290 | 730 | 695 | D | 4 30°C 55% |
| SDN-60 | -20°C -15°C | -4°F +5°F | 1532 60 ⁵ / ₁₆ | 915 36 ¹ / ₃₂ | 805 32 ¹ / ₉ | 4 | 500 | 230V-50Hz | R290 | 907 | 784 | D | 4 30°C 55% |

* ver pag 13- see pag 13

Características técnicas y constructivas sujetas a variación sin previo aviso.

- Exterior e interior en acero, excepto respaldo y fondo
- Puertas de apertura reversible, con sistema de cierre automático y burlete magnético (permanece abierta al superar los 90° de apertura)
- Encimera inox AISI-304
- Estantes interiores de alambre en acero plastificado, regulables en altura
- Ruedas de serie (2 con freno + 2 sin freno)
- Unidad condensadora ventilada
- Evaporador sistema tiro forzado, con recubrimiento epoxi anticorrosión
- Evaporación automática del agua de descarche
- Aislamiento de poliuretano inyectado, densidad 40 Kg/m³, cero GWP y cero efecto ODP
- Control digital de temperatura, descarches optimizados, alarma por alta temperatura de condensación. Eficiente gestión del consumo de energía
- Temperatura de trabajo a 38°C ambiente

We reserve the right to change specifications without prior notice.

- Stainless steel interior and exterior, except rear side and base
- Doors with self closing system, blocked opening, magnetic gasket and possibility of changing the opening sense
- AISI 304 stainless steel worktop
- Shelves made of plasticized steel wire, height adjustable
- Castors as standard (2 with brakes + 2 without)
- Fan assisted condenser unit
- Fan assisted evaporator, with epoxi anticorrosion coating.
- Automatic evaporation of defrost water
- 40 Kg/m³ density polyurethane insulation, zero GWP and zero ODP effect
- Digital temperature control, optimized defrost, high-temperature condensation alarm. Efficient management of energy consumption
- Operating temperature, 38°C ambient



SD-72
 con cajoneras opcionales
 with optional drawers sets

Puertas con doble bisagra
 Double hinged doors



OPCIONES

OPTIONS

| | |
|-----------------------|--------------------------|
| encimera con peto | worktop with splash-back |
| set 4 patas | set 4 legs |
| set 6 patas | set 6 legs |
| respaldo inox | SS rear side |
| tropicalizado 43°C | tropicalized 43 °C |
| 230V 60Hz / 115V 60Hz | 230V 60Hz / 115V 60Hz |



SD-27



SD-48



SD-72

US RANGE **7**



SDV-27



SDV-48



SDV-60



SDV-72

| mod. | rango range | | largo length (mm) (inch) | alto height (mm) (inch) | fondo depth (mm) (inch) | estantes shelves uds | volumen capacity (L) | voltaje voltage | refrigerante refrigerant | potencia frig. frig. power W | potencia power W | CCE EEC 2015/1094 EN16825 | clase climate 2015/1094 EN16825 |
|--------|----------------|--------------|---|--|---------------------------------------|----------------------------|----------------------------|--------------------|-----------------------------|------------------------------------|------------------------|------------------------------------|--|
| SDV-27 | -2°C +8°C | 28°F 46°F | 701 27 ³ / ₅ | 915 36 ¹ / ₃₂ | 805 32 ¹ / ₉ | 2 | 204 | 230V-50Hz | R134a* | 304 | 349 | - | 5 40°C 40% |
| | | | | | | | | | R290 | 502 | 271 | C | 5 40°C 40% |
| SDV-48 | -2°C +8°C | 28°F 46°F | 1228 48 ¹ / ₃ | 915 36 ¹ / ₃₂ | 805 32 ¹ / ₉ | 4 | 394 | 230V-50Hz | R134a* | 336 | 298 | - | 5 40°C 40% |
| | | | | | | | | | R290 | 502 | 737 | C | 5 40°C 40% |
| SDV-60 | -2°C +8°C | 28°F 46°F | 1532 60 ⁵ / ₁₆ | 915 36 ¹ / ₃₂ | 805 32 ¹ / ₉ | 4 | 500 | 230V-50Hz | R134a* | 485 | 466 | - | 5 40°C 40% |
| | | | | | | | | | R290 | 845 | 941 | D | 5 40°C 40% |
| SDV-72 | -2°C +8°C | 28°F 46°F | 1837 72 ¹ / ₃ | 915 36 ¹ / ₃₂ | 805 32 ¹ / ₉ | 6 | 606 | 230V-50Hz | R134a* | 540 | 487 | - | 5 40°C 40% |
| | | | | | | | | | R290 | 845 | 952 | D | 5 40°C 40% |

* ver pag 13- see pag 13

Características técnicas y constructivas sujetas a variación sin previo aviso.

- Exterior e interior en acero, excepto respaldo y fondo
- Puertas de doble cristal, sobre marco de aluminio
- Puertas de apertura reversible, con sistema de cierre automático y burlete magnético (permanece abierta al superar los 90° de apertura)
- Encimera inox AISI-304
- Estantes interiores de alambre en acero plastificado, regulables en altura
- Ruedas de serie (2 con freno + 2 sin freno)
- Unidad condensadora ventilada
- Evaporador sistema tiro forzado, con recubrimiento epoxi anticorrosión
- Evaporación automática del agua de descarche
- Aislamiento de poliuretano inyectado, densidad 40 Kg/m³, cero GWP y cero efecto ODP
- Control digital de temperatura, descarches optimizados, alarma por alta temperatura de condensación. Eficiente gestión del consumo de energía
- Temperatura de trabajo a 32°C ambiente

We reserve the right to change specifications without prior notice.

- *Stainless steel interior and exterior, except rear side and base*
- *Double glazed doors, with aluminium frame*
- *Doors with self closing system, blocked opening, magnetic gasket and possibility of changing the opening sense*
- *AISI 304 stainless steel worktop*
- *Shelves made of plasticized steel wire, height adjustable*
- *Castors as standard (2 with brakes + 2 without)*
- *Fan assisted condenser unit*
- *Fan assisted evaporator, with epoxi anticorrosion coating.*
- *Automatic evaporation of defrost water*
- *40 Kg/m³ density polyurethane insulation, zero GWP and zero ODP effect*
- *Digital temperature control, optimized defrost, high-temperature condensation alarm. Efficient management of energy consumption*
- *Operating temperature, 32°C ambient*



SDV-72

Puertas con doble bisagra
Double hinged doors**OPCIONES**

| | |
|------------------------------|--------------------------|
| encimera con peto | worktop with splash-back |
| set 4 patas | set 4 legs |
| set 6 patas | set 6 legs |
| registrador de alarmas HACCP | HACCP alarm recorder |
| respaldo inox | SS rear side |
| tropicalizado 43°C | tropicalized 43 °C |
| 230V 60Hz / 115V 60Hz | 230V 60Hz / 115V 60Hz |

OPTIONS

| |
|--------------------------|
| worktop with splash-back |
| set 4 legs |
| set 6 legs |
| HACCP alarm recorder |
| SS rear side |
| tropicalized 43 °C |
| 230V 60Hz / 115V 60Hz |

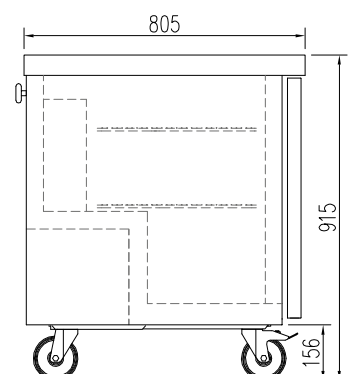



SDV-27



SDV-48



SDT-27-8



SDT-48-12



SDT-60-16



SDT-72-18

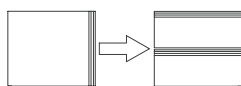

Incremento precio por cambio de puerta a cajonera doble, sistema autocierre
Door to double drawers set, soft-closing system, increase of price

Cubetas GN NO incluidas en el precio, ver página 411
GN containers NOT included in price see page 411

| mod. | rango range | largo length (mm) (inch) | fondo depth (mm) (inch) | perfiles GN GN supports | estantes shelves uds | encimera worktop GN1/6-100 | volumen capacity (L) | voltaje voltage | refrigerante refrigerant | potencia frig. frig. power W | potencia power W | |
|-----------|----------------|-----------------------------------|---|---------------------------------------|----------------------------|----------------------------------|----------------------------|--------------------|-----------------------------|------------------------------------|------------------------|-----|
| SDT-27-8 | 0°C +8°C | 32°F 46°F | 701 27 ³ / ₅ | 805 32 ¹ / ₉ | 1 | 2 | 8 | 204 | 230V-50Hz | R134a* | 304 | 343 |
| | | | | | | | | | | R290 | 502 | 264 |
| SDT-48-12 | 0°C +8°C | 32°F 46°F | 1228 48 ¹ / ₃ | 805 32 ¹ / ₉ | 1 | 4 | 12 | 394 | 230V-50Hz | R134a* | 336 | 286 |
| | | | | | | | | | | R290 | 502 | 725 |
| SDT-60-16 | 0°C +8°C | 32°F 46°F | 1532 60 ⁵ / ₁₆ | 805 32 ¹ / ₉ | 1 | 4 | 16 | 500 | 230V-50Hz | R134a* | 485 | 455 |
| | | | | | | | | | | R290 | 845 | 929 |
| SDT-72-18 | 0°C +8°C | 32°F 46°F | 1837 72 ¹ / ₃ | 805 32 ¹ / ₉ | 1 | 6 | 18 | 606 | 230V-50Hz | R134a* | 540 | 470 |
| | | | | | | | | | | R290 | 845 | 935 |

* ver pag 13- see pag 13

Características técnicas y constructivas sujetas a variación sin previo aviso.

- Exterior e interior en acero, excepto respaldo y fondo
- Puertas de apertura reversible, con sistema de cierre automático y burlete magnético (permanece abierta al superar los 90° de apertura)
- Encimera inox AISI 304 con tabla de polietileno desmontable, color blanco
- Estantes interiores de alambre en acero plastificado, regulables en altura
- Capacidad cubetas GN en la encimera
- Cubierta inox AISI-304, aislada, abatible sobre alojamiento cubetas
- Estantes interiores de alambre en acero plastificado, regulables en altura
- Ruedas de serie (2 con freno + 2 sin freno)
- Unidad condensadora ventilada
- Evaporador sistema tiro forzado, con recubrimiento epoxi anticorrosión
- Evaporación automática del agua de descarche
- Aislamiento de poliuretano inyectado, densidad 40 Kg/m³, cero GWP y cero efecto ODP
- Control digital de temperatura, descarches optimizados, alarma por alta temperatura de condensación. Eficiente gestión del consumo de energía
- Temperatura de trabajo 0°C +8°C a 38°C ambiente

We reserve the right to change specifications without prior notice.

- Stainless steel interior and exterior, except rear side and base
- Doors with self closing system, blocked opening, magnetic gasket and possibility of changing the opening sense
- AISI-304 stainless steel worktop, with detachable white polyethylene table
- Shelves made of plasticized steel wire, height adjustable
- GN capacity in the worktop
- AISI 304 stainless steel lid, isolated and hinged
- Shelves made of plasticized steel wire, height adjustable
- Castors as standard (2 with brakes + 2 without)
- Fan assisted condenser unit
- Fan assisted evaporator, with epoxi anticorrosion coating.
- Automatic evaporation of defrost water
- 40 Kg/m³ density polyurethane insulation, zero GWP and zero ODP effect
- Digital temperature control, optimized defrost, high-temperature condensation alarm. Efficient management of energy consumption
- Operating temperature 0°C +8°C, 38°C ambient



SDT-72-18

con cajonera opcional
with optional drawer set

Puertas con doble bisagra y burlete desmontable
Double hinged doors and detachable sgasket

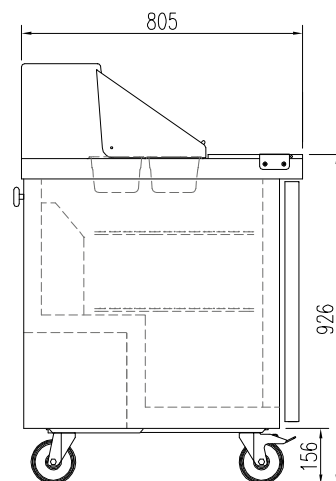

OPCIONES

| | |
|------------------------------|--------------------------|
| encimera con peto | worktop with splash-back |
| set 4 patas | set 4 legs |
| set 6 patas | set 6 legs |
| registrador de alarmas HACCP | HACCP alarm recorder |
| respaldo inox | SS rear side |
| tropicalizado 43°C | tropicalized 43 °C |
| 230V 60Hz / 115V 60Hz | 230V 60Hz / 115V 60Hz |

OPTIONS



SDT-27-8



SDT-72-18

Capacidad - GN 1/6-100 - Capacity

SDT-27-8

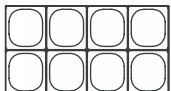

SDT-48-12

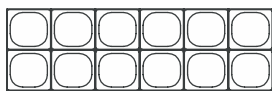

SDT-60-16

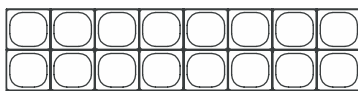

SDT-72-18

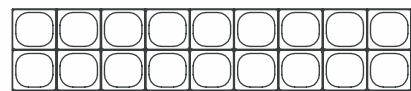



SDTP-27-12



SDTP-48-18



SDTP-60-24



SDTP-72-27

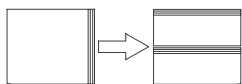

Incremento precio por cambio de puerta a cajonera doble, sistema autocierre
Door to double drawers set, soft-closing system, increase of price

Cubetas GN NO incluidas en el precio, ver página 411
GN containers NOT included in price see page 411

| mod. | rango range | largo length (mm) (inch) | fondo depth (mm) (inch) | perfiles GN GN supports | estantes shelves uds | encimera worktop GN1/6-100 | volumen capacity (L) | voltaje voltage | refrigerante refrigerant | potencia frig. frig. power W | potencia power W | |
|------------|----------------|-----------------------------------|---|---------------------------------------|----------------------------|----------------------------------|----------------------------|--------------------|-----------------------------|------------------------------------|------------------------|-----|
| SDTP-27-12 | 0°C +8°C | 32°F 46°F | 701 27 ³ / ₅ | 805 32 ¹ / ₉ | 2 | 2 | 12 | 204 | 230V-50Hz | R134a* | 304 | 343 |
| | | | | | | | | | | R290 | 502 | 264 |
| SDTP-48-18 | 0°C +8°C | 32°F 46°F | 1228 48 ¹ / ₃ | 805 32 ¹ / ₉ | 2 | 4 | 18 | 394 | 230V-50Hz | R134a* | 336 | 286 |
| | | | | | | | | | | R290 | 502 | 725 |
| SDTP-60-24 | 0°C +8°C | 32°F 46°F | 1532 60 ⁵ / ₁₆ | 805 32 ¹ / ₉ | 2 | 4 | 24 | 500 | 230V-50Hz | R134a* | 485 | 455 |
| | | | | | | | | | | R290 | 845 | 929 |
| SDTP-72-27 | 0°C +8°C | 32°F 46°F | 1837 72 ¹ / ₃ | 805 32 ¹ / ₉ | 2 | 6 | 27 | 606 | 230V-50Hz | R134a* | 540 | 470 |
| | | | | | | | | | | R290 | 845 | 935 |

* ver pag 13- see pag 13

Características técnicas y constructivas sujetas a variación sin previo aviso.

- Exterior e interior en acero, excepto respaldo y fondo
- Puertas de apertura reversible, con sistema de cierre automático y burlete magnético (permanece abierta al superar los 90° de apertura)
- Encimera inox AISI 304 con tabla de polietileno desmontable, color blanco
- Estantes interiores de alambre en acero plastificado, regulables en altura
- Capacidad cubetas GN en la encimera
- Cubierta inox AISI-304, aislada, abatible sobre alojamiento cubetas
- Estantes interiores de alambre en acero plastificado, regulables en altura
- Ruedas de serie (2 con freno + 2 sin freno)
- Unidad condensadora ventilada
- Evaporador sistema tiro forzado, con recubrimiento epoxi anticorrosión
- Evaporación automática del agua de descarche
- Aislamiento de poliuretano inyectado, densidad 40 Kg/m³, cero GWP y cero efecto ODP
- Control digital de temperatura, descarches optimizados, alarma por alta temperatura de condensación. Eficiente gestión del consumo de energía
- Temperatura de trabajo 0°C +8°C a 38°C ambiente

We reserve the right to change specifications without prior notice.

- Stainless steel interior and exterior, except rear side and base
- Doors with self closing system, blocked opening, magnetic gasket and possibility of changing the opening sense
- AISI-304 stainless steel worktop, with detachable white polyethylene table
- Shelves made of plasticized steel wire, height adjustable
- GN capacity in the worktop
- AISI 304 stainless steel lid, isolated and hinged
- Shelves made of plasticized steel wire, height adjustable
- Castors as standard (2 with brakes + 2 without)
- Fan assisted condenser unit
- Fan assisted evaporator, with epoxi anticorrosion coating.
- Automatic evaporation of defrost water
- 40 Kg/m³ density polyurethane insulation, zero GWP and zero ODP effect
- Digital temperature control, optimized defrost, high-temperature condensation alarm. Efficient management of energy consumption
- Operating temperature 0°C +8°C , 38°C ambient



SDTP-72-27
 con cajonera opcional
with optional drawer set



Puertas con doble bisagra
Double hinged doors

| OPCIONES | OPTIONS |
|------------------------------|--------------------------|
| encimera con peto | worktop with splash-back |
| set 4 patas | set 4 legs |
| set 6 patas | set 6 legs |
| registrador de alarmas HACCP | HACCP alarm recorder |
| respaldo inox | SS rear side |
| tropicalizado 43°C | tropicalized 43 °C |
| 230V 60Hz / 115V 60Hz | 230V 60Hz / 115V 60Hz |

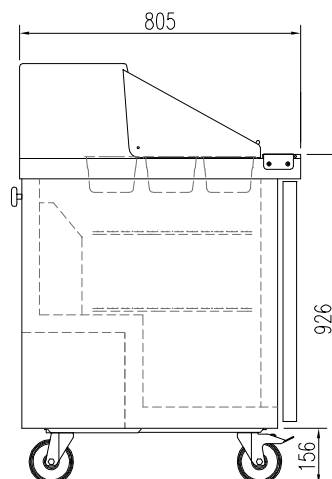



SDTP-27-12



SDTP-72-27

Capacidad - GN 1/6-100 - Capacity

SDTP-27-12

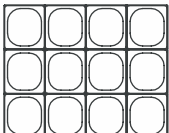

SDTP-48-18

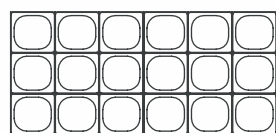

SDTP-60-24

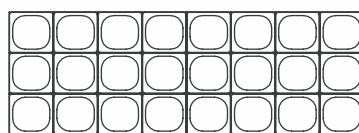

SDTP-72-27

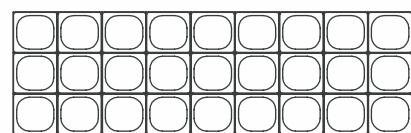



SDTP-27-9-LGL 3.077 €



SDTP-48-18-LGL 3.771 €

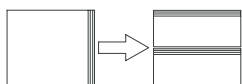

Incremento precio por cambio de puerta a cajonera doble, sistema autocierre
 Door to double drawers set, soft-closing system, increase of price

Cubetas GN NO incluidas en el precio, ver página 411
GN containers NOT included in price see page 411

| mod. | rango range | largo length (mm) (inch) | fondo depth (mm) (inch) | perfiles GN GN supports | estantes shelves uds | encimera worktop GN1/6-100 | volumen capacity (L) | voltaje voltage | refrigerante refrigerant | potencia frig. frig. power W | potencia power W | |
|----------------|----------------|-----------------------------------|--|---------------------------------------|----------------------------|----------------------------------|----------------------------|--------------------|-----------------------------|------------------------------------|------------------------|-----|
| SDTP-27-9-LGL | 0°C +8°C | 32°F 46°F | 701 27 ³ / ₅ | 830 32 ² / ₃ | 2 | 2 | 9 | 204 | 230V-50Hz | R134a* | 304 | 296 |
| | | | | | | | | | | R290 | 502 | 275 |
| SDTP-48-18-LGL | 0°C +8°C | 32°F 46°F | 1228 48 ¹ / ₃ | 830 32 ² / ₃ | 2 | 4 | 18 | 394 | 230V-50Hz | R134a* | 336 | 353 |
| | | | | | | | | | | R290 | 502 | 375 |

* ver pag 13- see pag 13

Características técnicas y constructivas sujetas a variación sin previo aviso.

- Exterior en acero, incluido el respaldo
- Interior en acero, con aristas curvas y fondo embutido
- Puertas de apertura reversible, con sistema de cierre automático y burlete magnético (permanece abierta al superar los 90° de apertura)
- Encimera inox con capacidad cubetas GN (ver detalle)
 - Tabla de corte en polietileno
 - Perfiles divisorios fijos (desmontable para limpieza) para apoyo de las cubetas
 - Robusta estructura elevable, con doble cristal para mantener la temperatura del área de cubetas
 - Máxima visibilidad del producto, LED 6500 K
 - Opción LED 3000 K (luz cálida) o Rosa al mismo precio
 - Sellado del perímetro de la cubierta por burletes
- Sistema de pistones y amortiguadores para compensar el peso
- Estantes interiores de alambre en acero plastificado, regulables en altura
- Ruedas de serie (2 con freno + 2 sin freno)
- Unidad condensadora ventilada
- Evaporador sistema tiro forzado, con recubrimiento epoxi anticorrosión
- Evaporación automática del agua de descarche
- Aislamiento de poliuretano inyectado, densidad 40 Kg/m³, cero efectos ODP y GWP
- Control digital de temperatura, descarches optimizados, alarma por alta temperatura de condensación. Eficiente gestión del consumo de energía
- Temperatura de trabajo a 32°C ambiente

We reserve the right to change specifications without prior notice.

- Stainless steel exterior, rear side included
- Stainless steel interior, stamped bottom and rounded corners
- Doors with self closing system, blocked opening, magnetic gasket and possibility of changing the opening sense
- AISI-304 worktop, capacity for GN containers (see detail)
 - Polyethylene cutting table
 - Fixed pan dividers (detachable for cleaning)
 - Heavy-duty double liftable glass lid to keep temperature in the GN pans
 - Maximum product visibility by 6500 K LED
 - Optional 300 K LED (soft light) or Pink, same price
 - Perimetral gasket around the lid structure
- Piston system to help the opening /closing of the structure
- Shelves made of plasticized steel wire, height adjustable
- Castors as standard (2 with brakes + 2 without)
- Removable and fan assisted condenser unit
- Fan assisted evaporator, with epoxi anticorrosion coating.
- Automatic evaporation of defrost water
- 40 Kg/m³ density polyurethane insulation, zero ODP and GWP
- Digital temperature control, optimized defrost, high-temperature condensation alarm. Efficient management of energy consumption
- Operating temperature 32°C ambient

Puertas con doble bisagra y burlete desmontable
 Double hinged doors and detachable gasket

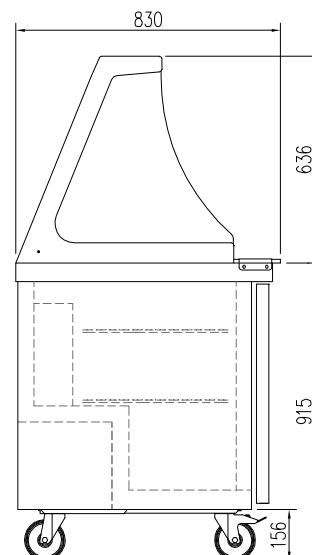

| OPCIONES | OPTIONS |
|------------------------------|-----------------------|
| set 4 patas | set 4 legs |
| set 6 patas | set 6 legs |
| registrador de alarmas HACCP | HACCP alarm recorder |
| respaldo inox | SS rear side |
| 230V 60Hz / 115V 60Hz | 230V 60Hz / 115V 60Hz |



SDTP-48-18-LGL



SDTP-48-18-LGL
con cajonera opcional
with optional drawer set



DTP-48-18 -LGL

US RANGE 7



| | | | | |
|--------|----------|--------|----------|--------|
| UPR-27 | UPR-27-2 | UPR-55 | UPR-55-4 | UPR-82 |
| UPL-27 | UPL-27-2 | UPL-55 | UPL-55-4 | UPL-82 |

| mod. | rango range | largo length (mm) (inch) | alto height (mm) (inch) | fondo depth (mm) (inch) | estantes shelves GN 2/1 | volumen capacity (L) | voltaje voltage | refrigerante refrigerant | potencia frig. frig. power W | potencia power W | CCE EEC 2015/1094 EN16825 | clase climate 2015/1094 EN16825 | |
|--------|----------------|--------------------------|-------------------------|-------------------------|-------------------------|----------------------|-----------------|--------------------------|------------------------------|------------------|---------------------------|---------------------------------|------------|
| UPR-27 | -2°C +8°C | 28°F 46°F | 660 26 | 2145 847/16 | 845 331/4 | 3 | 645 | 230V-50Hz | R134a* | 245 | 253 | - | 5 40°C 40% |
| | | | | | | | | | R290 | 502 | 243 | C | 5 40°C 40% |
| UPR-55 | -2°C +8°C | 28°F 46°F | 1350 561/16 | 2145 847/16 | 845 331/4 | 6+3 | 1404 | 230V-50Hz | R134a* | 485 | 442 | - | 5 40°C 40% |
| | | | | | | | | | R290 | 845 | 373 | D | 5 40°C 40% |
| UPR-82 | -2°C +8°C | 28°F 46°F | 2035 801/8 | 2145 847/16 | 845 331/4 | 9+6 | 2197 | 230V-50Hz | R290 | 1702 | 897 | D | 5 40°C 40% |
| | | | | | | | | | R449A* | 1215 | 894 | - | 5 40°C 40% |
| UPL-27 | -20°C -15°C | -4°F +5°F | 660 26 | 2145 847/16 | 845 331/4 | 3 | 645 | 230V-50Hz | R290 | 606 | 553 | E | 5 40°C 40% |
| | | | | | | | | | R449A* | 452 | 620 | - | 4 30°C 55% |
| UPL-55 | -20°C -15°C | -4°F +5°F | 1350 561/16 | 2145 847/16 | 845 331/4 | 6+3 | 1404 | 230V-50Hz | R290 | 907 | 952 | E | 4 30°C 55% |
| | | | | | | | | | R449A* | 1042 | 990 | - | 4 30°C 55% |
| UPL-82 | -20°C -15°C | -4°F +5°F | 2035 801/8 | 2145 847/16 | 845 331/4 | 9+6 | 2197 | 230V-50Hz | R290 | 1814 | 1680 | E | 4 30°C 55% |
| | | | | | | | | | R449A* | 1630 | 194 | - | 4 30°C 55% |

* ver pag 13- see pag 13

Características técnicas y constructivas sujetas a variación sin previo aviso.

We reserve the right to change specifications without prior notice.

- Exterior en acero excepto el respaldo y fondo
- Interior en acero, con aristas curvas y fondo embutido
- Puertas de apertura reversible, con sistema de cierre automático y burlete magnético (permanece abierta al superar los 90° de apertura)
- Contrapuerta inox embutida
- Luz interior LED
- Estantes interiores de alambre en acero plastificado, regulables en altura
- Ruedas de serie (2 con freno + 2 sin freno)
- Cuadro de mandos y rejilla ventilación motor, desmontables
- Unidad condensadora ventilada
- Evaporador sistema tiro forzado, con recubrimiento epoxi anticorrosión
- Paro ventiladores tiro forzado al abrir la puerta
- Evaporación automática del agua de descarche
- Aislamiento de poliuretano inyectado, densidad 40 Kg/m³, cero efectos GWP y ODP
- Control digital de temperatura, descarches optimizados, alarma por alta temperatura de condensación. Eficiente gestión del consumo de energía
- Temperatura de trabajo : 38°C

- Stainless steel exterior, except rear side and base
- Stainless steel interior, stamped bottom and rounded corners
- Doors with self closing system, blocked opening, magnetic gasket and possibility of changing the opening sense
- Inner side of doors by stamped steel
- LED lighting
- Shelves made of plasticized steel wire, height adjustable
- Castors as standard (2 with brakes + 2 without)
- Control panel and engine ventilation grill, removable
- Fan assisted condenser unit
- Fan assisted evaporator, with epoxi anticorrosion coating
- Evaporator fan stops when door is opened
- Automatic evaporation of defrost water
- 40Kg/m³ density polyurethane insulation, zero ODP and GWP
- Digital temperature control, optimized defrost, high-temperature condensation alarm. Efficient management of energy consumption
- Operating temperature: : 38°C

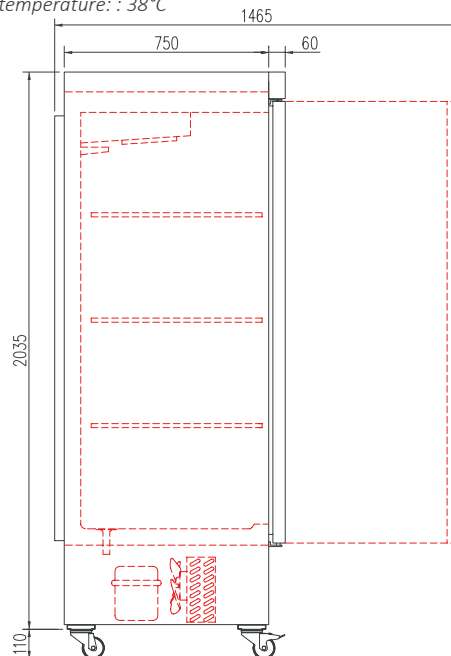

| OPCIONES | OPTIONS |
|--------------------------------|-----------------------|
| parrilla adicional | additional grill |
| cerradura puerta inox superior | upper SS door lock |
| barras carniceras | meat bars |
| set 4 patas | set 4 legs |
| set 5 patas | set 5 legs |
| set 6 patas | set 6 legs |
| respaldo inox | SS rear side |
| tropicalizado 43°C | tropicalized 43 °C |
| 230V 60Hz / 115V 60Hz | 230V 60Hz / 115V 60Hz |



UPR-82



UPR-27



UPR-55

US RANGE **7**



UPR-27G
UPL-27G

UPR-55G
UPL-55G

UPR-82G
UPL-82G

| mod. | rango range | largo length (mm) (inch) | alto height (mm) (inch) | fondo depth (mm) (inch) | estantes shelves GN 2/1 | volumen capacity (L) | voltaje voltage | refrigerante refrigerant | potencia frig. frig. power W | potencia power W | CCE EEC 2015/1094 EN16825 | clase climate 2015/1094 EN16825 |
|---------|--------------------------------|--------------------------|-------------------------|-------------------------|-------------------------|----------------------|-----------------|--------------------------|------------------------------|------------------|---------------------------|---------------------------------|
| UPR-27G | -2°C +8°C 28°F 46°F | 660 26 | 2145 84 7/16 | 845 33 1/4 | 4 | 645 | 230V-50Hz | R134a* R290 | 245 502 | 264 260 | - C | 4 30°C 55% 5 40°C 40% |
| UPR-55G | -2°C +8°C 28°F 46°F | 1350 56 1/16 | 2145 84 7/16 | 845 33 1/4 | 8+4 | 1404 | 230V-50Hz | R452* R290 | 452 606 | 627 560 | - D | 4 30°C 55% 4 30°C 55% |
| UPR-82G | -2°C +8°C 28°F 46°F | 2035 80 1/8 | 2145 84 7/16 | 845 33 1/4 | 12+8 | 2197 | 230V-50Hz | R134a* R290 | 485 845 | 461 396 | - E | 4 30°C 55% 4 30°C 55% |
| UPL-27G | -20°C -15°C -4°F +5°F | 660 26 | 2145 84 7/16 | 845 33 1/4 | 4 | 645 | 230V-50Hz | R449A* R290 | 1042 907 | 1010 902 | - E | 4 30°C 55% 4 30°C 55% |
| UPL-55G | -20°C -15°C -4°F +5°F | 1350 56 1/16 | 2145 84 7/16 | 845 33 1/4 | 8+4 | 1404 | 230V-50Hz | R290 R449A* | 1702 1215 | 943 932 | - - | 4 30°C 55% 4 30°C 55% |
| UPL-82G | -20°C -15°C -4°F +5°F | 2035 80 1/8 | 2145 84 7/16 | 845 33 1/4 | 12+8 | 2197 | 230V-50Hz | R290 R449A* | 1814 1630 | 1726 1640 | - - | 3 25°C 60% 4 30°C 55% |

* ver pag 13- see pag 13

Características técnicas y constructivas sujetas a variación sin previo aviso.

- Exterior en acero excepto el respaldo y fondo
- Interior en acero, con aristas curvas y fondo embutido
- Puertas de apertura reversible, con sistema de cierre automático y burlete magnético (permanece abierta al superar los 90° de apertura)
- Doble cristal
- Luz interior LED
- Estantes interiores de alambre en acero plastificado, regulables en altura
- Ruedas de serie (2 con freno + 2 sin freno)
- Cuadro de mandos y rejilla ventilación motor, desmontables
- Unidad condensadora ventilada
- Evaporador sistema tiro forzado, con recubrimiento epoxi anticorrosión
- Paro ventiladores tiro forzado al abrir la puerta
- Evaporación automática del agua de descarche
- Aislamiento de poliuretano inyectado, densidad 40 Kg/m³, cero efectos ODP y GWP
- Control digital de temperatura, descarches optimizados, alarma por alta temperatura de condensación. Eficiente gestión del consumo de energía
- Temperatura de trabajo : 32°C

We reserve the right to change specifications without prior notice

- Stainless steel exterior, except rear side and base
- Stainless steel interior, stamped bottom and rounded corners
- Doors with self closing system, blocked opening, magnetic gasket and possibility of changing the opening sense
- Double glazed door
- LED lighting
- Shelves made of plasticized steel wire, height adjustable
- Castors as standard (2 with brakes + 2 without)
- Control panel and engine ventilation grill, removable
- Fan assisted condenser unit
- Fan assisted evaporator, with epoxi anticorrosion coating
- Evaporator fan stops when door is opened
- Automatic evaporation of defrost water
- 40 Kg/m³ density polyurethane insulation, zero ODP and GWP
- Digital temperature control, optimized defrost, high-temperature condensation alarm. Efficient management of energy consumption
- Operating temperature: : 32°C

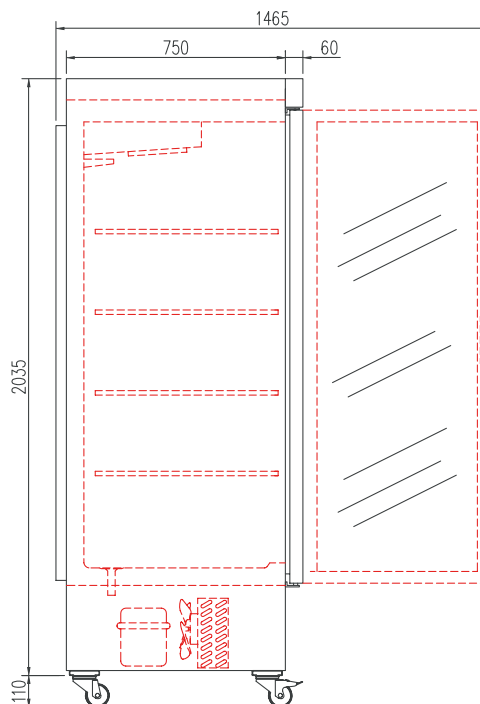

| OPCIONES | OPTIONS |
|------------------------------|-----------------------|
| parrilla adicional | additional grill |
| cerradura puerta cristal | glass door lock |
| barras carniceras | meat bars |
| set 4 patas | set 4 legs |
| set 5 patas | set 5 legs |
| set 6 patas | set 6 legs |
| registrador de alarmas HACCP | HACCP alarm recorder |
| respaldo inox | SS rear side |
| tropicalizado 43°C | tropicalized 43 °C |
| 230V 60Hz / 115V 60Hz | 230V 60Hz / 115V 60Hz |



UPR-82G



UPR-55G



UPR-27G

US RANGE **7**